

Accell H

HYBRID TECHNOLOGY





About Us

With over 45 years in the marketplace, Accurpress continues to build on its tested history to manufacture an innovative and complete line of press brakes and shears for every bending and shearing application. Proudly North American made, Accurpress leads the way with high tonnage machines, revolutionary pole bending technologies, tandem machines, and robot automation. With over 21,000 machines sold to thousands of satisfied customers, Accurpress continues to build press brakes and shears to meet the demands of today's manufacturing environments.

“While 45 years have brought huge changes to the machine tool industry, all of us at Accurpress continues to stand firm on the original foundation of quality that the company was built on. Every Accurpress machine, including the one you’ll buy, is made with 100% of our best efforts. Our business depends on it and so does yours.”

Steve Hilton
President

The **ACCELL** Lineup

A Complete Line of Y1/Y2 Machines

Accell H

HYBRID TECHNOLOGY



Accell H 190 Ton



Accell H 60 Ton

Available from 60 - 190 Tons

The **Accell H** exceeds performance expectations with its high speed forming and ability to tackle any application challenge. With advanced motion technologies and the most flexible features and options, the Accell H is the ultimate in creating complex parts.

Accell E

THE COMPETITIVE EDGE



Accell U

Available from 75 - 500 Tons

The **Accell E** is the complete package. With a high-quality build, an impressive number of features and options, competitive pricing and advanced controls, this is your first choice in Y1/Y2 machine technology. **Accell U** is an upgrade to the Accell E.

Reference **ACCELL E Brochure** for complete list of features and options.

Accell HT

HIGH TONNAGE



Available from 650 - 3000 Tons

The **Accell HT** features rugged builds, oversized components and powerful gauging devices. These machines are tough and durable and will stand up to any forming challenge. If you want to bend something big, we've got you covered.

Reference **ACCELL HT Brochure** for complete list of features and options.

ACCELL H

60 - 190 Ton Models

The Accell H 120 - 190 ton models combine power and precision into a sleek design. Using a combination of Electric and Hydraulic Drive Systems, these hybrid machines are highly efficient, impressively quiet and utilize the latest in Accurpress Motion Technologies.



120 - 190 Ton Models



60 Ton

HYBRID MACHINES

ACCELL HU Upgrade Package

120 - 190 Ton Models

The Accell H 120 - 190 ton models can be upgraded to The Accell HU Package. All of the features of the Accell H model are included, with the addition of upgraded machine covers, Vision drop-down screen and the 6-axis Supreme backgauge.



Optional Moses Control

HYBRID TECHNOLOGY

Choose an Accurpress Hybrid Machine

1 High Energy Efficiency

The Accurpress Hybrid machines use a combination of hydraulic and Servo Drive systems to control ram motion resulting in dramatically reduced energy costs. There is no hydraulic pump, meaning no energy consumption when the machine is at idle and the counterbalanced return stroke requires almost no energy to raise the ram.

2 Low Noise

The Hybrid is the quietest Accurpress machine available. With no hydraulic pump, shop noise is reduced significantly.

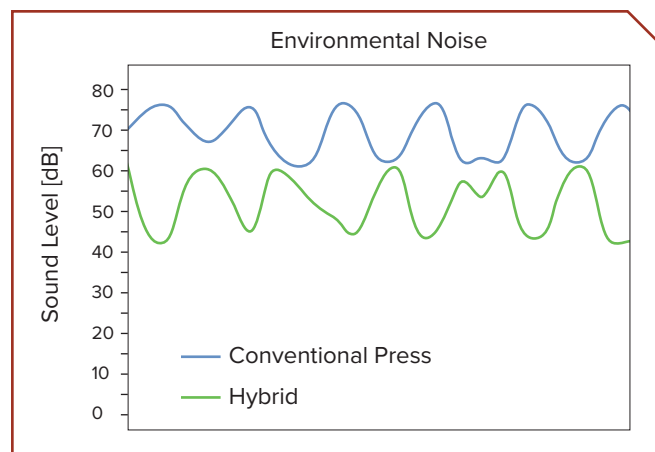

3 Fiessler Safety Systems

The Fiessler AKAS 3F laser guarding system comes standard on the 120 and 190 ton Hybrid models and protects the operator from pinch point hazard of closing tooling. The 60 ton Hybrid model comes standard with the Fiessler light curtain safety system and the laser guarding system can be added as an option.

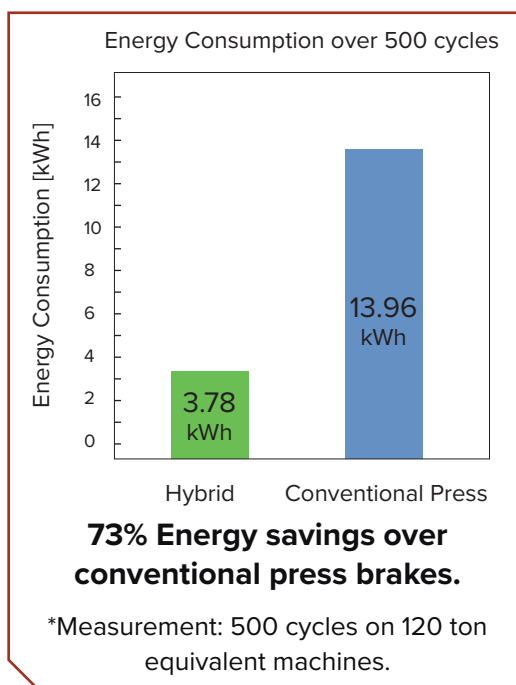
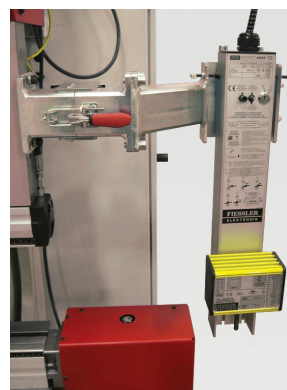

4 Ultimate in Speed and Accuracy

Ram repeat and positional accuracies are at an amazing +/- 0.0002 and ram approach and return speeds at 540 IPM make this the fastest machine in the Accurpress lineup.

5 Streamlined Design

Accurpress Hybrid machines are easy to service and maintain. The oil reservoir contains only a couple of gallons of Hydraulic oil with a 7000 hour change interval. Also, there is no external plumbing so the possibility of leaks is greatly reduced.



MATERIAL COMPENSATION

Teach Crowning

The Teach Crowning feature eliminates the need to manually adjust crowning values. A crowning sensor measures machine deflection in real-time and automatically updates the Vision Program.

When additional Crowning is needed, simply depress the foot pedal a second time to form the part using the corrected crowning value.

Theoretical Crowning value BEFORE forming.



Real Time Crowning Adjustment AFTER forming.



Pressure Compensation

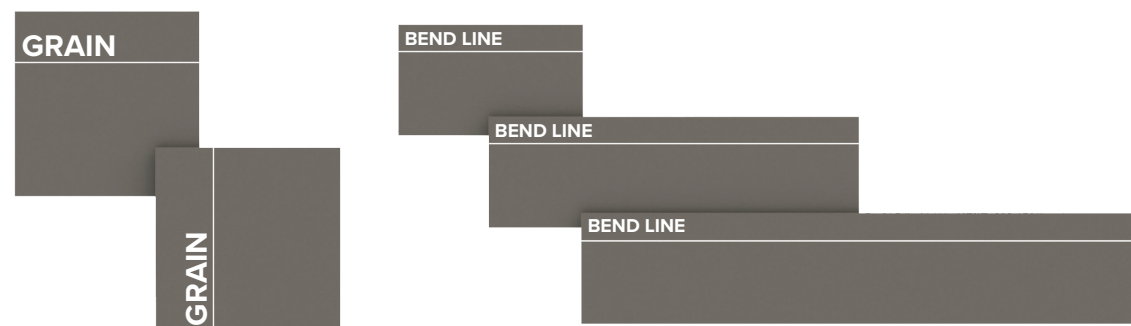

The Accell Hybrid senses variations in pressure between bending with or against the material grain and senses different bend line lengths. Variations can be automatically compensated for, resulting in consistent angle performance. This feature is ideal for material grain, bend lines and tensile strength variances.

Material Thickness Sensing System

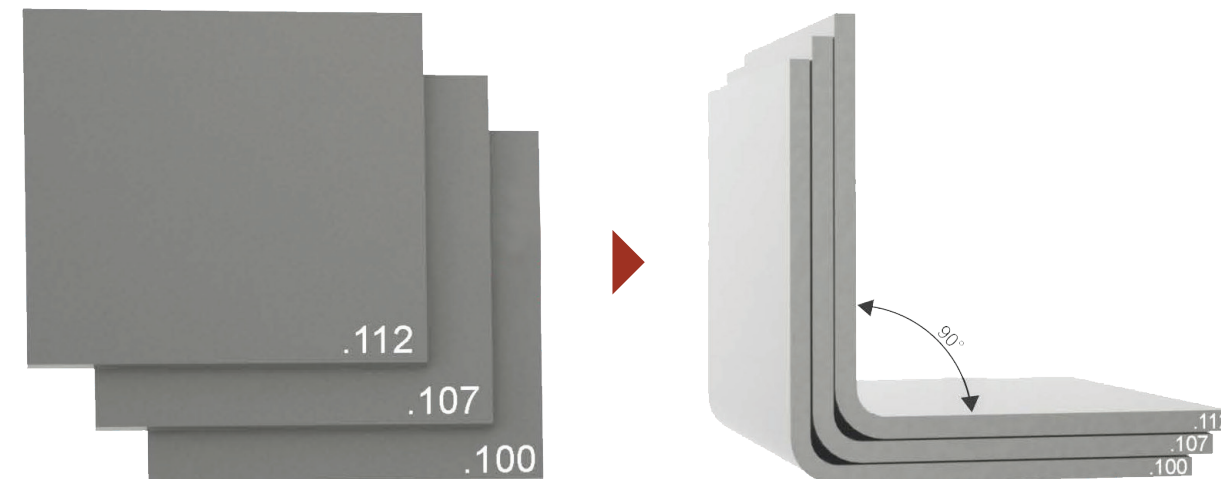

During the bending process, the Accell measures variations and inconsistencies in material thickness and then self-adjusts to maintain accurate angle performance.

The Material Thickness Sensing system also has a built-in safety feature when material thickness is detected outside of an acceptable range. In this case, when significant differences in material are detected, the ram will stop downward motion and return stately to the top of the stroke.

The **ACCELL H**

60 Ton Model - Hybrid Technology

The **Accell H** 60 ton machine is all about features. This smart and accessible machine has so much packed into the frame that whatever forming challenge you have in mind, it has got you covered. Everything from the revolutionary ALLY backgauge, optional dual screens and intelligent design makes this machine an obvious choice for forming smaller parts.

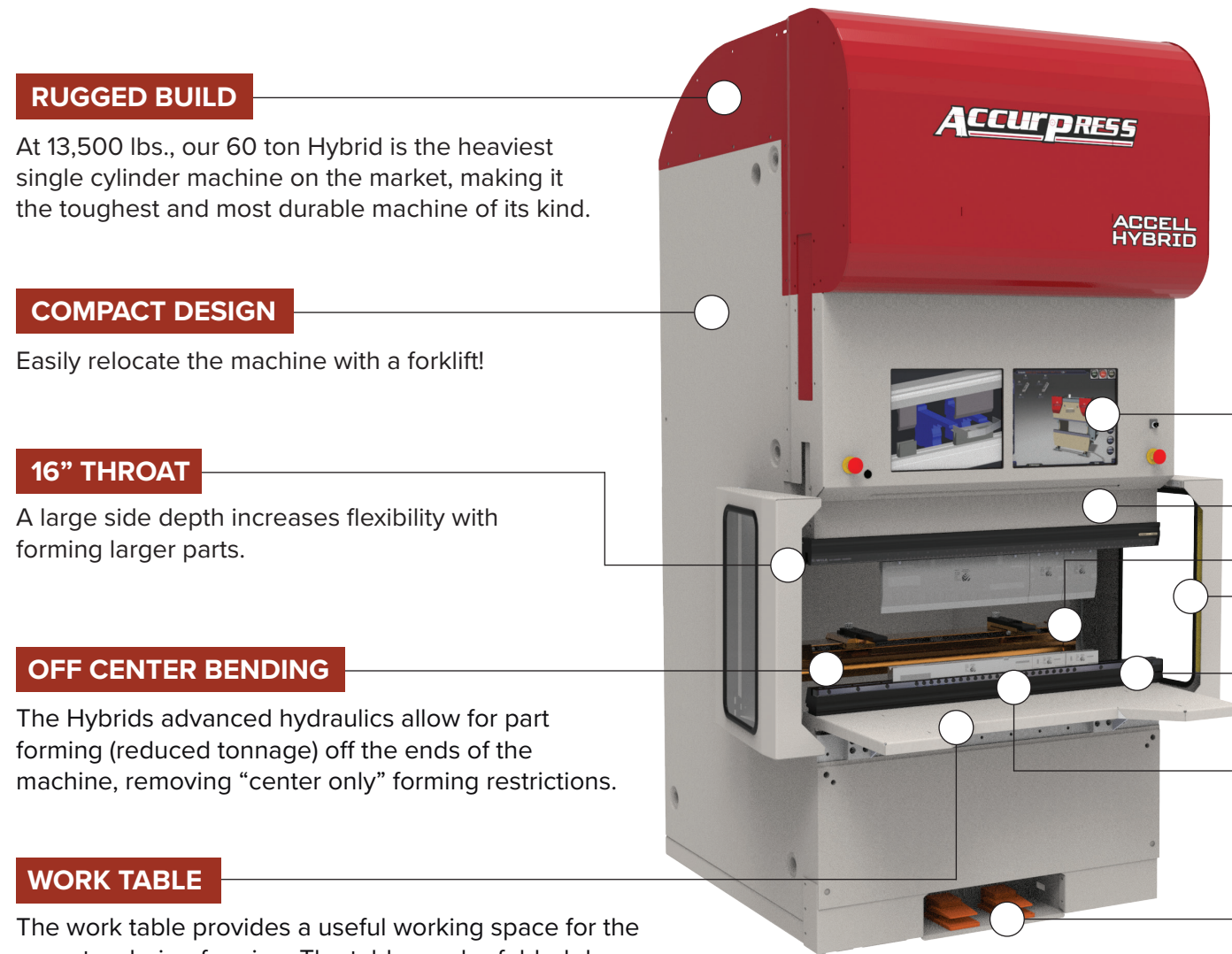

RUGGED BUILD

At 13,500 lbs., our 60 ton Hybrid is the heaviest single cylinder machine on the market, making it the toughest and most durable machine of its kind.

COMPACT DESIGN

Easily relocate the machine with a forklift!

16" THROAT

A large side depth increases flexibility with forming larger parts.

OFF CENTER BENDING

The Hybrids advanced hydraulics allow for part forming (reduced tonnage) off the ends of the machine, removing "center only" forming restrictions.

WORK TABLE

The work table provides a useful working space for the operator during forming. The table can be folded down when not in use.

MACHINE CONTROLS

The powerful and easy to use Vision Control comes standard. Add an optional extra screen for convenient file management and display of PDF part drawings. (Note: Moses Control upgrade for 60 ton comes standard with dual screens).

WILA CLAMPING

All Hybrid models come standard with either Wila NSCL1 New Standard Pro or ASCL1 American ram clamping systems.

ALLY 4-AXIS BACKGAUGE

Specifically designed for the 60 ton machine, the 4-axis CNC backgauge (X, R, Z1/Z2) comes standard with three finger rests and full range of motion across all axes. (Optional 5 and 7-axis models available)

LIGHT CURTAIN RAM INITIATION/GUARDING

Ram motion can be initiated by breaking the light curtain beam rather than using the foot pedal. This is great for increasing production times and reducing operator fatigue.

MATERIAL COMPENSATION

Material Thickness Sensing, Teach Crowning and Pressure Compensation all provide real time positioning adjustments based on material variance.

ACCURPRESS BOTTOM DIE HOLDER

Optional localized adjusters and clamping bars in lieu of set screws.

RECESSED FOOT PEDAL

Foot pedal can be extended or recessed for preferred use.

The **ACCELL H**

120 - 190 Ton Models - Hybrid Technology

The **Accell H** 120 - 190 ton models combine power and precision into a sleek design. Using a combination of Electric and Hydraulic Drive Systems, these hybrid machines are highly efficient, impressively quiet and utilize the latest in Accurpress Motion Technologies.

4 POINT RAM GUIDE WAYS

The Four Point Ram Guiding System allows for stable ram movement even with larger open heights and stroke lengths. The ram moves freely up and down via 4 hardened Roller Ways.

FISSLER LASER GUARDING

The Fiessler system transmits 3 lasers across the tooling area and monitors any interference as the parts are formed. In the event of an unplanned obstruction in the laser area, the ram is immediately stopped, protecting the operator.

16" THROAT DEPTH

A large side depth increases flexibility with forming larger parts.

REAR SAFETY DOOR

The backgauge area is completely protected via sliding doors and safety interlock switch.

VISION CONTROL

The powerful and easy to use Vision Control comes standard with all Accell Hybrid models. Optional MOSES upgrade is available.

CONTROL HEAD WORK STATION

The Vision control display has a convenient area for a keyboard, mouse and even your coffee mug!

WILA CLAMPING

All Hybrid models come standard with either Wila NSCL1 New Standard Pro or ASCL1 American ram clamping systems.

CNC ACCURCROWN DIE HOLDER

The Accurcrown system provides a uniform crown via precision wedges that compensate for machine deflection. This is fully integrated into Vision and the Material Compensation System.

OPTIONAL PRECISION SHEET SUPPORTS

The bed of the machine is prepared for optional Precision Sheet Supports. This allows for easy installation of these support fixtures at any point.

MATERIAL COMPENSATION SYSTEM

Material Thickness Sensing, Teach Crowning and Pressure Compensation all provide real time positioning adjustments based on material variance.

OFF CENTER FORMING

The Hybrids advanced hydraulics allow for part forming (reduced tonnage) off the ends of the machine, removing "center only" forming restrictions.

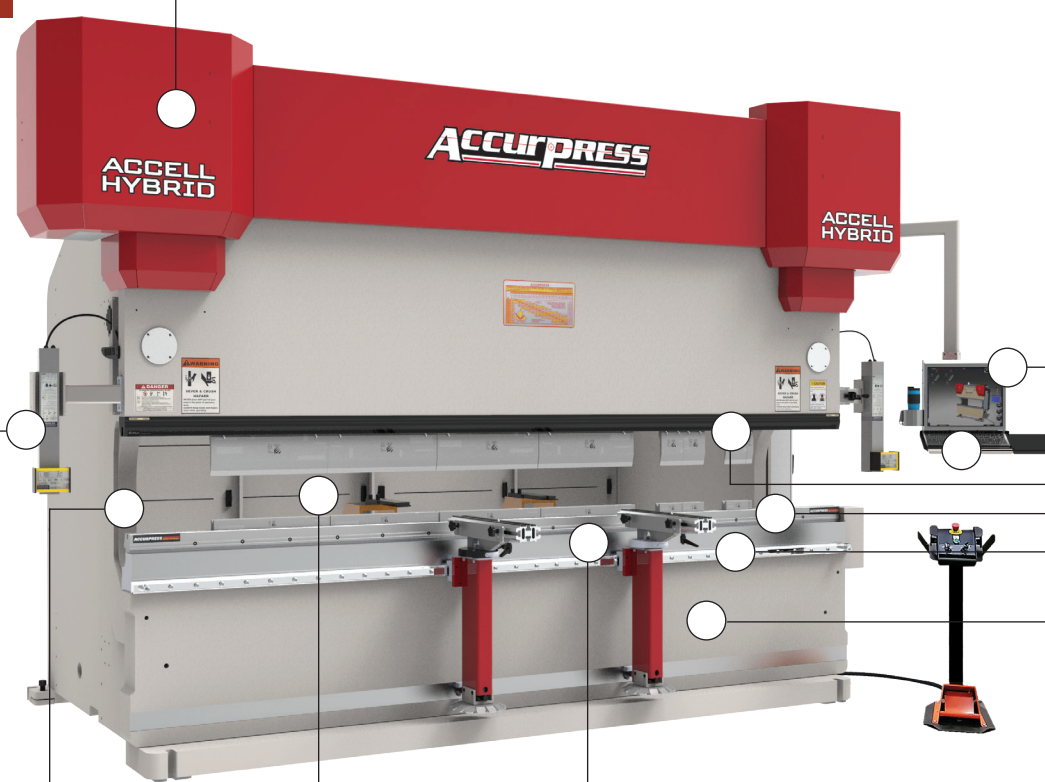

The **ACCELL HU**

Accell HU Hybrid Upgrade Package

The **Accell H** 120 - 190 ton models can be upgraded to The Accell HU Package. All of the features of the Accell H model are included with the following additions:

4 POINT RAM GUIDE WAYS

The Four Point Ram Guiding System allows for stable ram movement even with larger open heights and stroke lengths. The ram moves freely up and down via 4 hardened Roller Ways.

UPGRADED COVERS

Quality sheet metal panels protect the safety guarding system and give the Accell HU a signature new look. These panels swing open to allow for easy side loading of tooling and access to the safety system.

SUPREME BACKGAUGE

Combining speed with rigidity, the Supreme Backgauge offers independent 6-axis motion, notched fingers for offset and corner gauging and the highest heavy load capacity outside of the Titan Backgauge.

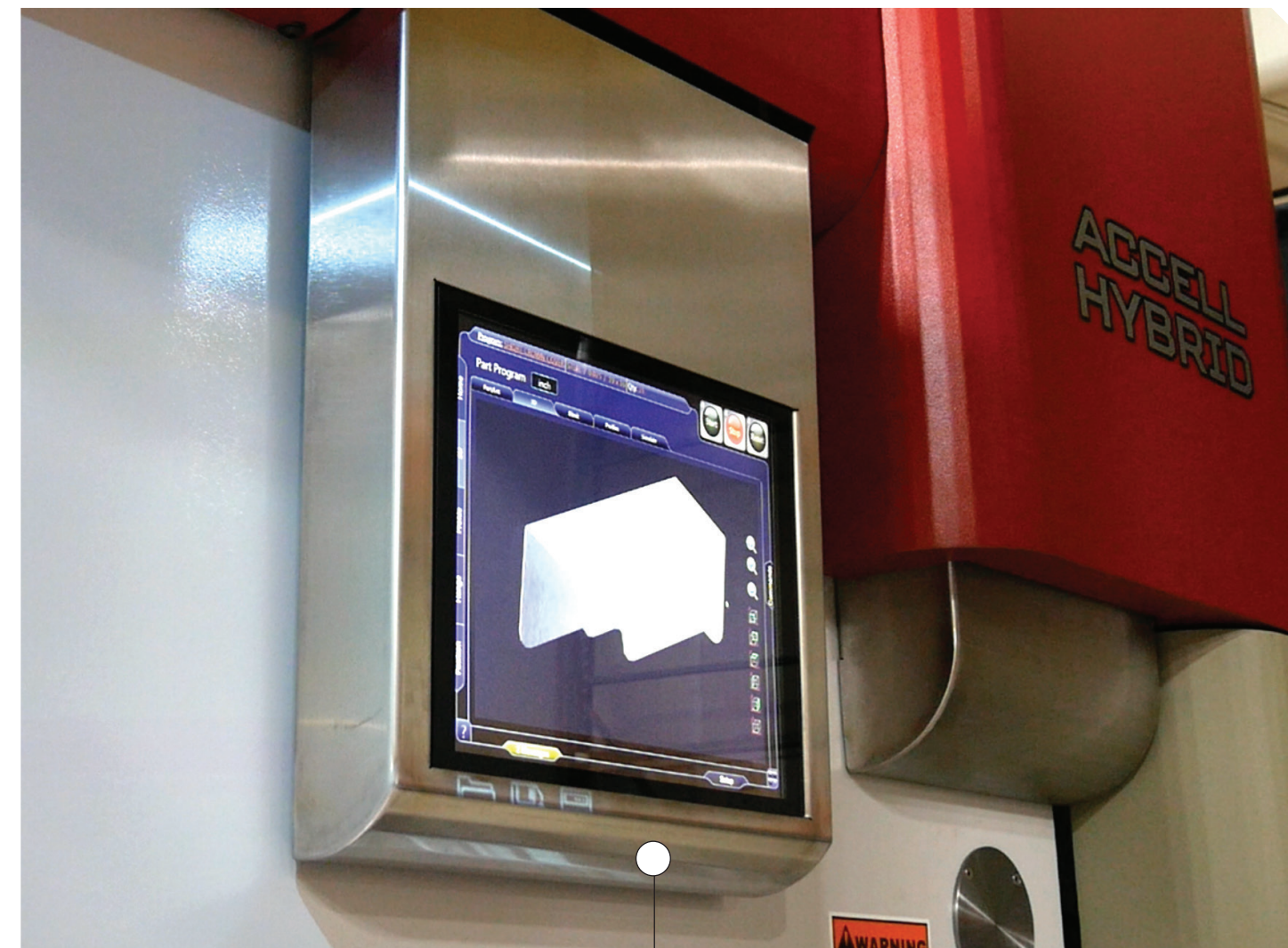
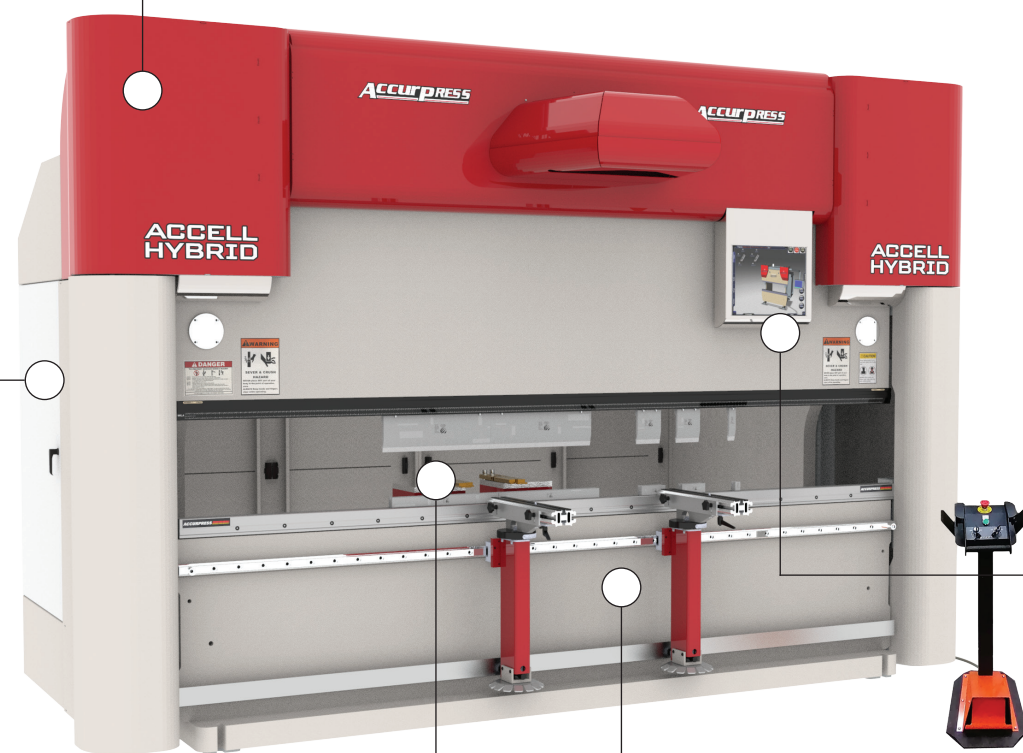

VISION CONTROL DROP DOWN SCREEN

The Vision control screen can be lowered down for programming use, then raised up and out of the way during forming. Screen up and down motion is controlled via a key selector switch on the Pedestal Control.

PRECISION SHEET SUPPORTS

Precision Sheets Supports are fully adjustable for different tooling heights and thicknesses. The bottom foot disc allows the operator to easily adjust the height of the support arms while the top support piece can be adjusted front to back depending on the desired foot position. These 24" supports are mounted on a linear rail for smooth and accurate positioning left to right on the press brake and also feature angle gauging, squaring bars and disappearing stops.

VISION Control

The Vision Control is a ground-breaking and revolutionary press brake control software system. Vision streamlines and simplifies the bending process, giving you full control over every aspect of metal forming.

FEATURES

- Touch screen control
- Automatic bend sequencing
- Automatic tool selection
- Quick tooling change
- Complete control over all axis
- Simple bump bending
- Special bend support such as offset, hemming and pre-bends
- Easily program custom tools



Sketch part profile using touchscreen

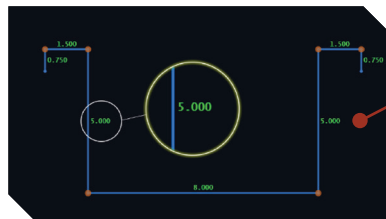

Easily add dimensions and angles



Confirm bend sequence and tooling

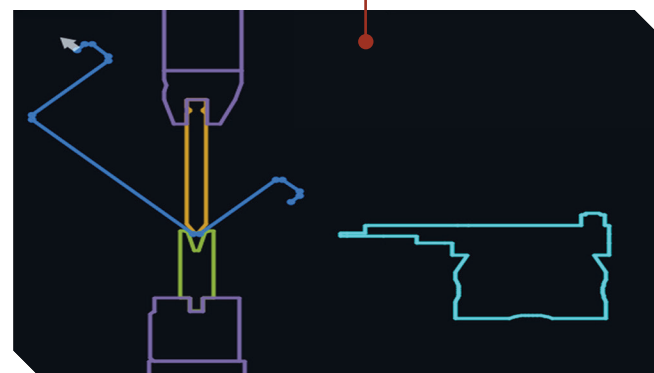

Begin forming

VISION 3D

Working with Solidworks or Inventor, Vision 3D lets you import part models into Vision for full 3D programming, bend visualization and dynamic viewing during the forming process.



Use VISION in your part models

FEATURES

- Accurate Bend Radius

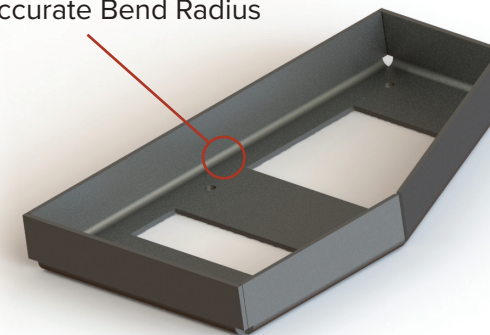

- Accurate Flat Patterns

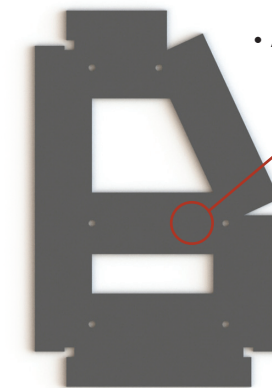

- Dynamic 3D Bend Simulation

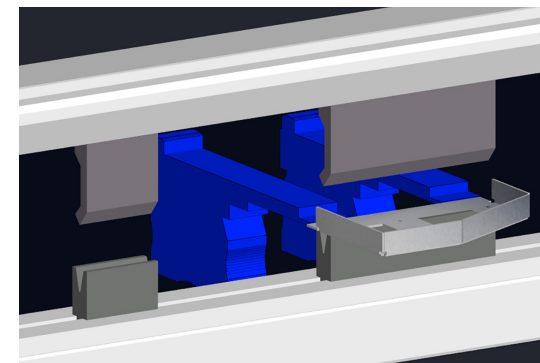

- Run 3D programs on the ETS3000



MOSES Control

This groundbreaking Vision Control Upgrade gives the operator the ability to edit and run programs in a full 3D visual environment. Bend sequencing and part orientation are fully animated and projected to the ram as the part is formed. Edits can be made to the program by using the ram as a touchscreen!



60 TON MODEL

On the 60 ton model, dual touch screen monitors are utilized to provide 3D simulation and easy program edits for the operator.

NOTE

Moses control upgrade for the 60 ton automatically includes a second screen.



120-190 TON MODELS

On the 120 and 190 ton models, a digital HD projector is installed on the top cover of the machine in a fully protected sheet metal shroud. 3D bend simulation visuals are projected onto the ram and allow the operator to make edits and change views by using the ram itself as the touchscreen.

LIGHT CURTAIN Ram Motion Initiation



RAM MOTION INITIATION

This feature is standard on all 60 ton models and can be added as an option for the 120 -190 ton models.

The Accurpress Hybrid has a feature that allows for ram motion to be initiated by interrupting the light curtain beam. This is a great feature that speeds up part forming production while also reducing operator fatigue by allowing the operator to move the ram without using the foot pedal.

BACKGAUGE Options

PREMIUM BACKGAUGE

The Premium backgauge is Accurpress' standard backgauge, available for all makes and models of Accurpress press brakes. Available in lengths from 6' to 24', the Premium backgauge is built with large section extrusions and roller carriage castings that maintain strength and accuracy over the life of the machine. This gauge is easily serviced and maintained and comes standard with X, R, Z1/Z2 powered axes.

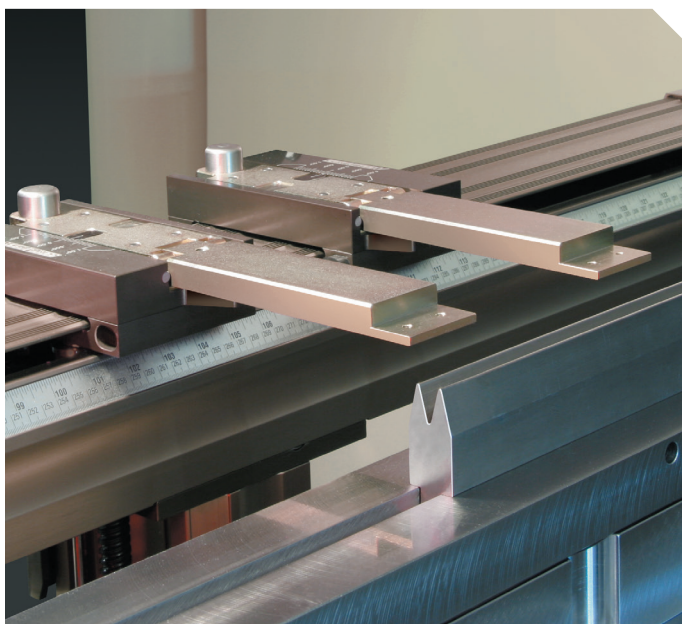

ELITE BACKGAUGE

The Elite backgauge offers full 6-axis part gauging via 2 independent gauging platforms that are mounted on a linear rail on the back of the bed. This rugged and accurate design combined with flexible gauging options and competitive pricing make the Elite backgauge your first-choice in 6-axis gauging. Rear guarding complete with gate and safety interlock switch, is installed for every Elite backgauge to meet all applicable safety standards.

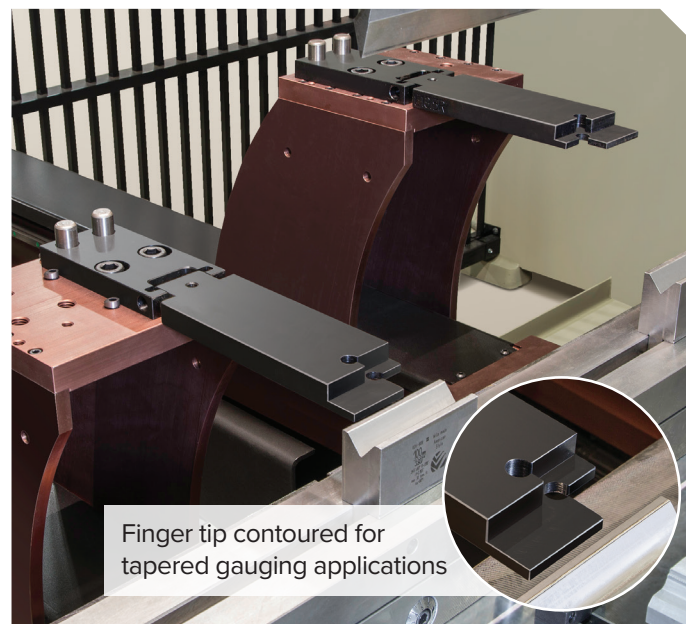

Finger tip contoured for tapered gauging applications

SUPREME BACKGAUGE

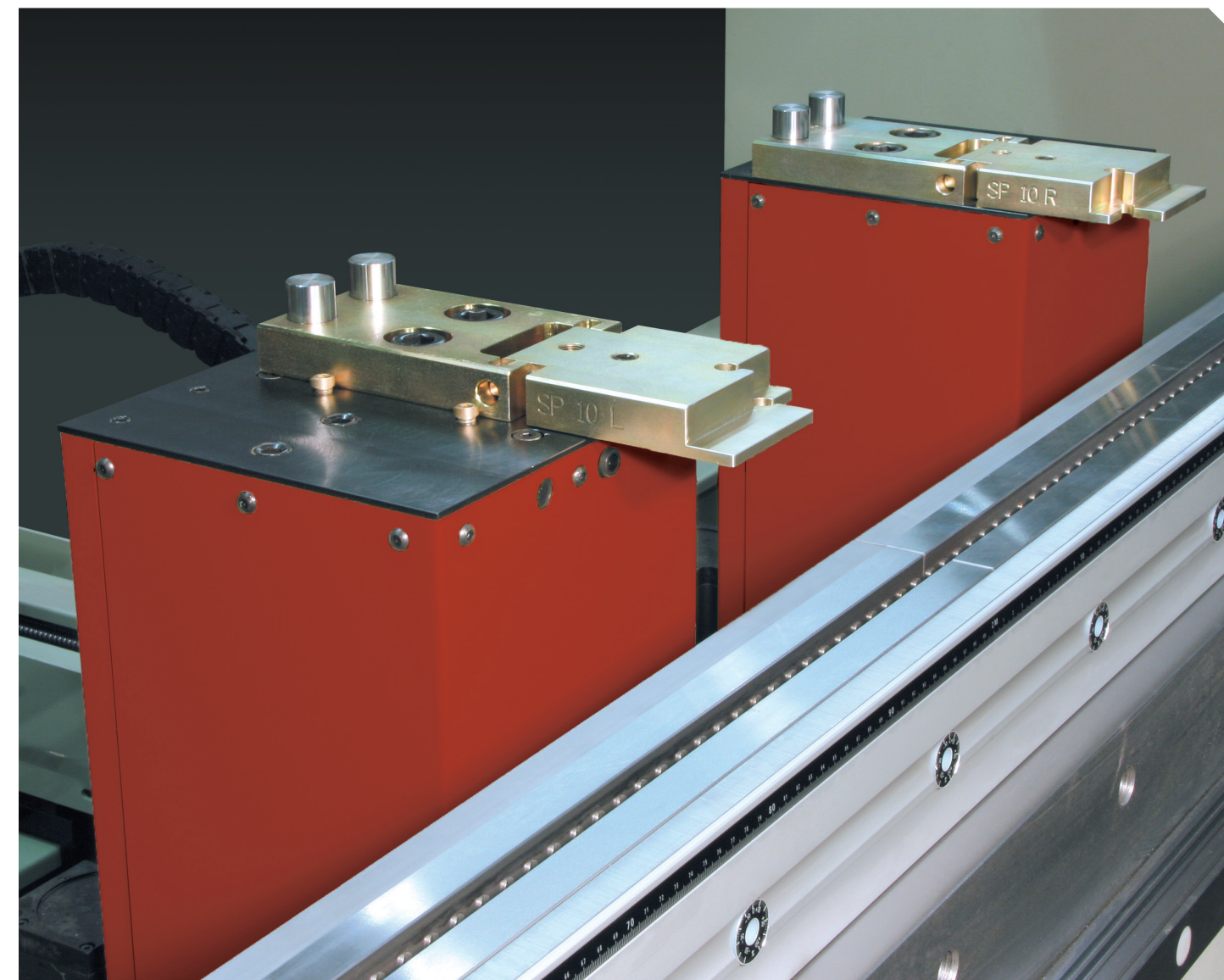

PREMIUM SPECIFICATIONS

	X-Axis	R-Axis	Z1/Z2-Axes
Axis Travel	24" - 39" 609.6 - 990.6 mm	10" 254 mm	Distance between side frames minus 16"
Positioning Speed	900 ipm	900 ipm	900 ipm
Position Repeatability	+/- 0.001"	+/- 0.001"	+/- 0.003"
Holding Force	750 lbs		

ELITE SPECIFICATIONS

	X-Axis	R-Axis	Z1/Z2-Axes
Axis Travel	39" 990.6 mm	13" 330.2 mm	Distance between side frames minus 24"
Positioning Speed	900 ipm	900 ipm	900 ipm
Position Repeatability	+/- 0.001"	+/- 0.001"	+/- 0.003"
Holding Force	1500 lbs		

The Supreme backgauge is Accurpress' 6-axis gauging system that meets the challenges of complex sheet metal parts and fast paced production environments. Constructed from a one-piece rugged steel platform that is isolated from machine ram movements, the Supreme backgauge maintains its accuracy and strength over the lifetime of the machine. Rear guarding, complete with gate and safety interlock switch, is installed for every Supreme backgauge to meet all applicable industry safety standards.

SUPREME SPECIFICATIONS

	X1/X2-Axes	R1/R2-Axes	Z1/Z2-Axes
Axis Travel	39" 990.6 mm	10" 254 mm	Distance between side frames minus 24"
Positioning Speed	1,500 ipm	1,500 ipm	1,500 ipm
Position Repeatability	+/- 0.005"	+/- 0.001"	+/- 0.002"
Holding Force	1,000 lbs		

NOTE: Premium and Elite are available for the H and HU Models.

NOTE: Supreme is available for the HU Models.

ACCELL H 60 Ton Backgauge Options

Ally Backgauge

The Ally Backgauge is available exclusively for the 60 ton Hybrid model and comes with three levels of gauging to meet any forming challenge. These gauging systems are installed in the body of the machine and provide varying levels of flexibility and automation.

4-AXIS

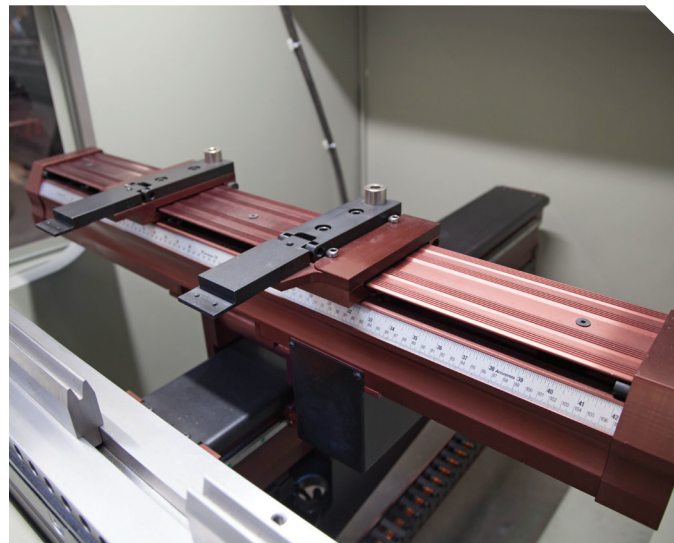

The Ally 4-axis backgauge has powered X,R and Z1/ Z2-axes. This gauge is ideal for parts with parallel bend lines to part edges. Powered R and Z1/Z2-axes allows for automatic gauge positioning, particularly with stage bending.

NOTE

All programing is fully supported in the Vision Control.

5-AXIS

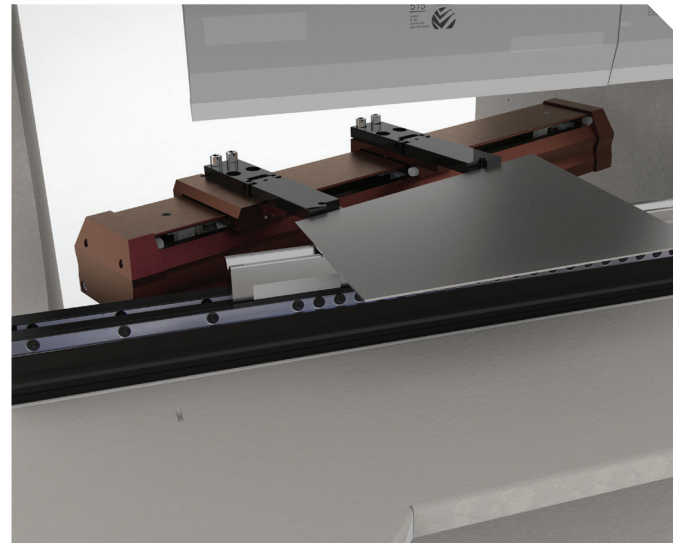

The Ally 5-axis backgauge has all the benefits of the 4-axis, with the addition of the 5th Xr-axis. This is the backgauge motion where the main Z bar can rotate clockwise or counterclockwise 30 degrees in order to gauge parts with non parallel bend lines. The two backgauge fingers are built with cut outs and corner notches to better assist in offset gauging.

NOTE

The 5-axis offset gauge feature is fully supported in the Vision control.

7-AXIS

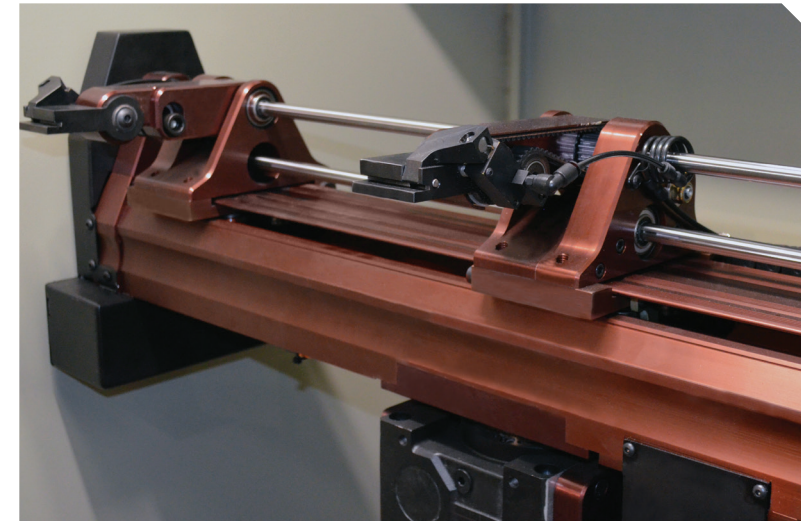

The Ally 7-axis backgauge has special clamping fingers that will clamp and hold the part, move into position and release/retract when the ram begins forming. This allows total control and part reorientation based on bend direction, bend sequence and multiple tool stages. Once the part is completed, Ally will pass the part back to the operator.

NOTE

The 7-axis Ally backgauge comes complete with a teach pendant for programming and is fully supported in the Vision control.

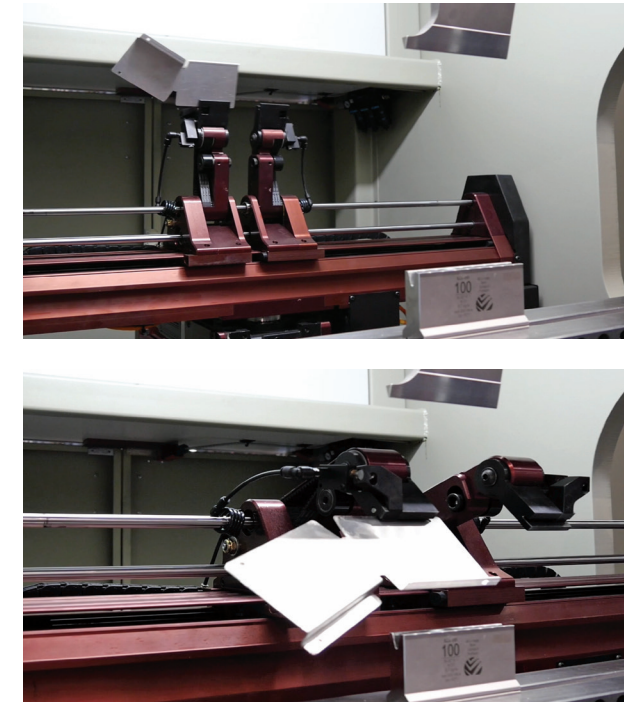

ALLY 7 Allowable Part Sizes for Manipulation

Depth (in.)	Width (in.)				
	6	12	18	24	30
6	x	x	x	x	x
8	x	x	x	x	
10	x	x	x		
12	x	x			
14	x				
16	x				
18	x				
20	x				

ALLY SPECIFICATIONS

	X-Axis	R-Axis	Z1/Z2-Axes	Xr-Axis 5-Axis	Xr-Axis 7-Axis	Arm Axis	Finger Axis (Relative to Arm)
Axis Travel	30"	13"	27"	-45 to +45	-25 to +205	-20 to +205	-135 to +90
Positioning Speed	900 ipm	900 ipm	900 ipm	90 ds	45 ds	45 ds	45 ds
Position Repeatability	+/- 0.001"	+/- 0.001"	+/- 0.001"	+/- 0.01"	+/- 0.25"	+/- 0.25"	+/- 0.25"
Holding Force	750 lbs						
Max Part Weight							5 lbs

ADDITIONAL Options

PRECISION FRONT SUPPORT ARMS

The Accurpress front support arms come standard in 24" length and are fully adjustable for different tooling heights and thicknesses. The bottom Foot Disk allows the operator to easily adjust the height of the support arm while the top support piece can be adjusted front to back depending on the desired position. These support arms are mounted on a liner rail for smooth and accurate posing left to right on the press brake. Both sizes feature angle gauging, squaring bars and disappearing stops.



NOTE: 24" Standard on Accell HU Models.

SECOND SCREEN (60 Ton Model)

A second screen can be added to the 60 ton model that helps with file management, opening network locations and reviewing part drawings.



SHEET FOLLOWERS

The Accurpress Sheet Following System is a moveable support table that lifts and supports material during the bending motion. It is fully synchronized with the ram bend speed and desired angle and can support a load capacity of 500lb per sheet follower. Descent speed and activation of the Sheet Following System are fully programmable by the operator.

ROBOTICS

Accurpress offers robotic press brake solutions for automated bending. Robotized bending combines the Accell press brake with experienced partners in robotics and offline software.

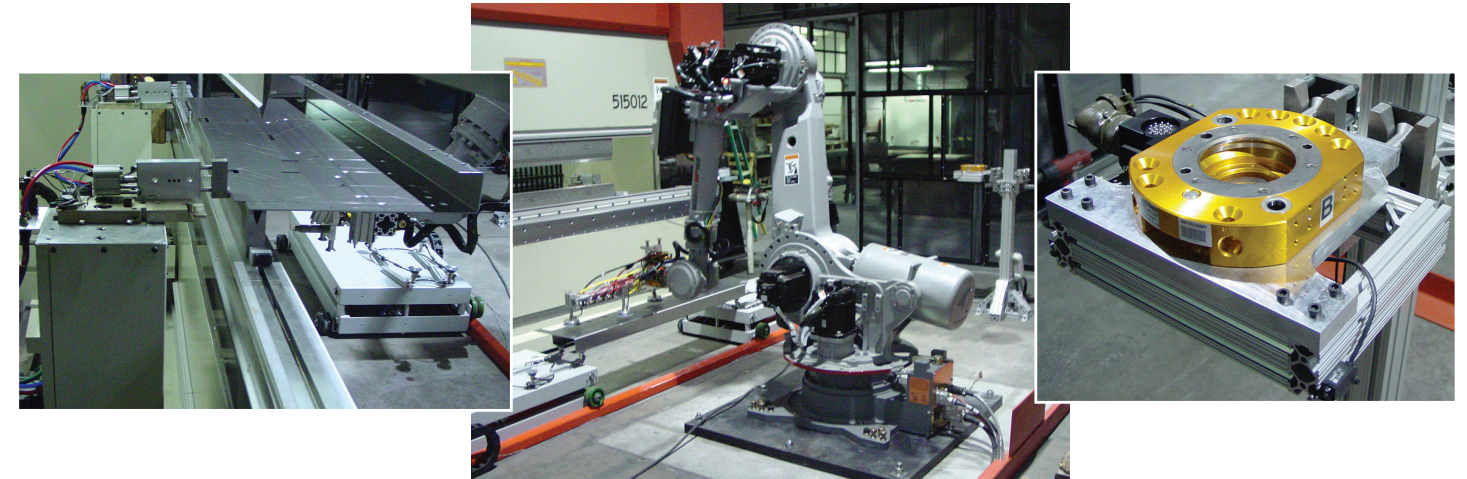

BARCODE READER

Two models available:
 1) Paper-read
 2) Paper-read/barcode etched in metal

NOTE: Vision Control required.



AiM - ANGLE MEASUREMENT SYSTEM

To provide the absolute optimum in high precision bending, Accurpress offers AiM - an Angle Measurement System as an optional accessory for the Accell-E, U, and H models. AiM is recommended for demanding applications where minute differences in material thickness, grain direction, or spring-back leave formed parts outside of accepted tolerances. This measurement device operates via sensors that may

be positioned anywhere along the length of the tooling to detect material and spring-back differences and makes instant adjustments resulting in highly precise formed pieces.

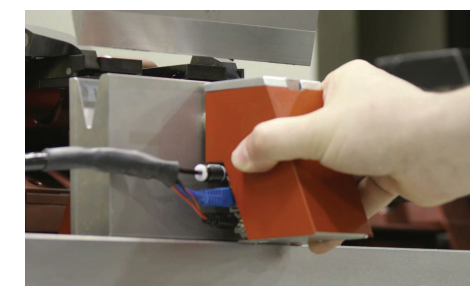
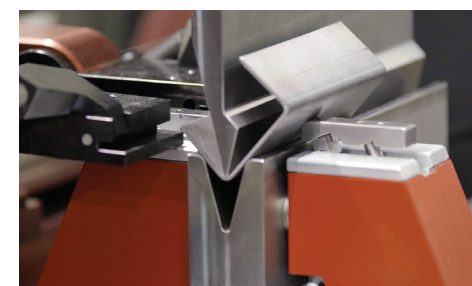

ACCELL H Specifications

MODEL NUMBER	TONS	BED HEIGHT	TOP BED WIDTH	RAM OPEN HEIGHT	RAM CLOSED HEIGHT	STROKE LENGTH	OVERALL DIMENSIONS (INCHES)						APPROX. SPEEDS (IN/MIN)			APPROX. SHIPPING WEIGHT (LB)
							A	B	C	D	E	F	APPROACH	BEND	RETURN	
5604/H	60	32	4	19	8	11	48	44	49	16	64	112	540	24	540	13,500
51206/H	120	34	4.75	19	8	11	72	58	102	16	77	112	540	24	540	19,000
51206/HU	120	34	4.75	19	8	11	72	58	102	16	77	112	540	24	540	19,000
51208/H	120	34	4.75	19	8	11	96	82	126	16	77	112	540	24	540	21,000
51208/HU	120	34	4.75	19	8	11	96	82	126	16	77	112	540	24	540	21,000
512010/H	120	34	4.75	19	8	11	120	106	150	16	77	112	540	24	540	23,000
512010/HU	120	34	4.75	19	8	11	120	106	150	16	77	112	540	24	540	23,000
512012/H	120	34	4.75	19	8	11	144	130	174	16	77	112	540	24	540	25,000
512012/HU	120	34	4.75	19	8	11	144	130	174	16	77	112	540	24	540	25,000
519010/H	190	34	4.75	19	8	11	120	106	151	16	80	116	540	24	540	30,000
519010/HU	190	34	5.75	19	8	11	120	106	151	16	80	116	540	24	540	30,000
519012/H	190	34	5.75	19	8	11	144	130	175	16	80	116	540	24	540	33,000
519012/HU	190	34	5.75	19	8	11	144	130	175	16	80	116	540	24	540	33,000
519014/H	190	34	5.75	19	8	11	168	154	199	16	80	116	540	24	540	37,500
519014/HU	190	34	5.75	19	8	11	168	154	199	16	08	116	540	24	540	37,500

OVERALL DEPTH OF 51208/H TO 519014/H INCREASES IF MOSES 3D VIRTUAL CONTROL IS PURCHASED.
 MACHINE SHIPPING WIDTHS AND WEIGHTS MAY CHANGE PENDING OPTIONAL ACCESSORIES. SPECIFICATIONS ARE SUBJECT TO CHANGE WITHOUT NOTICE.

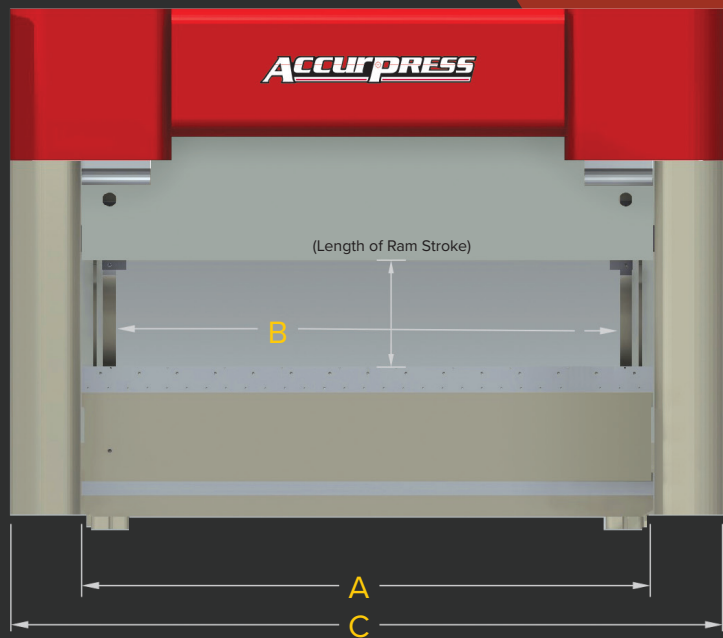
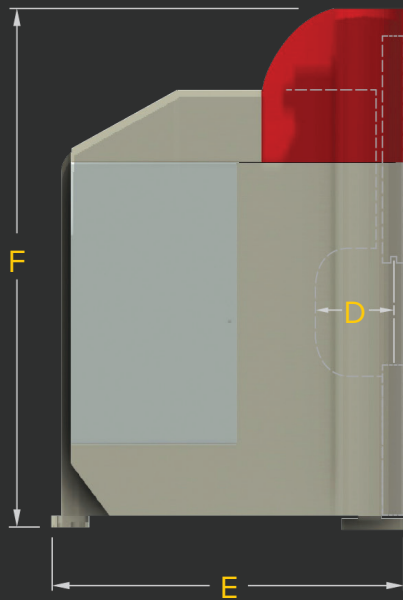

© Copyright April 2020

For more information about our products, please refer to our comprehensive brochures or visit our site www accurpress.com.