

METAL &  
COMPOSITES



***Waterjet***

# METAL & COMPOSITES



## THE METAL&COMPOSITES RANGE PRODUCTION

LA GAMMA COMPLETA METAL&COMPOSITES



CANTILEVER



**PRIMA LT**  
Flying Bridge 3 axis System with integrated steel tank.  
Sistema a 3 assi con vasca integrata in acciaio.

**PRATICA FB**  
Flying Bridge 3 axis System with separate steel tank  
Sistema rotante con ponte a sbalzo a 3 assi e vasca separata in acciaio.



GANTRY



**CLASSICA CL**  
Gantry 3-4-5 axis System with integrated stainless steel tank.  
Sistema a ponte con vasca integrata in acciaio inox a 3-4-5 assi.

**SUPREMA DX**  
3, 4 and 5 axis Accurate Gantry Motion Systems with separate stainless steel tank.  
Centro di Lavoro a 3-4-5 assi ad altissima precisione con vasca separata in acciaio inox.

MODEL MODELLO	CANTILEVER DESIGN		GANTRY DESIGN	
	PRIMA™	PRATICA™	CLASSICA®	SUPREMA®
44	1.250 x 1.250 mm 4' x 4'		1.250 x 1.250 mm 4' x 4'	1.250 x 1.250 mm 4' x 4'
510	3.400 x 1.650 mm 11' x 5' 1/2	3.000 x 2.000 mm 10' x 6' 1/2	3.400 x 1.800 mm 11' x 6'	3.350 x 1.600 mm 11' x 5' 1/2
610			3.400 x 2.000 mm 11' x 6' 1/2	3.350 x 2.000 mm 11' x 6' 1/2
612	4.000 x 1.650 mm 13' x 5' 1/2	4.000 x 2.000 mm 13' x 6' 1/2	4.000 x 2.000 mm 13' x 6' 1/2	4.000 x 2.000 mm 13' x 6' 1/2
812		4.000 x 2.500 mm 13' x 8'		4.000 x 2.500 mm 13' x 8'
1012				4.000 x 3.350 mm 13' x 11'
620		6.100 x 2.000 mm 20' x 6' 1/2	6.100 x 2.000 mm 20' x 6' 1/2	6.100 x 2.000 mm 20' x 6' 1/2
820		6.100 x 2.500 mm 20' x 8'		6.100 x 2.500 mm 20' x 8'
1020				6.100 x 3.350 mm 20' x 11'
1040				12.200 x 3.350 mm 40' x 11'
1340				12.200 x 4.000 mm 40' x 13'



# PLUG & PLAY CANTILEVER SYSTEM

SISTEMA COMPATTO PLUG & PLAY



Touch Probe Sensor with Anti-collision Device (optional)  
Tastatore con Anticollisione (opzionale)



## LT 510

3 axis NC Flying Bridge technology with Integrated Tank, Rack and pinion motion system with automatic lubrication.

Vasca integrata con tecnologia "Flying Bridge" gestita da controllo numerico a 3 assi Interpolanti. Trasmissione con pignone a cremagliera e lubrificazione automatica.

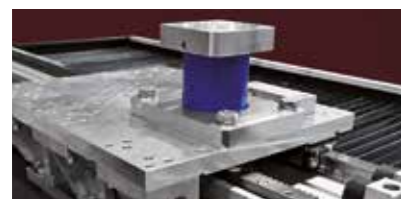

X = 3.400 mm Y = 1.650 mm Z = 200 mm	<b>Net Cutting Area</b> Area netta di taglio	X = 11' Y = 5' 1/2 Z = 8"
3.800 mm x 1.800 mm	<b>Inner Table Working Area</b> Dimensioni interne vasca	12' x 6'
4.000 mm x 2.300 mm x h 1.800 mm	<b>Overall Dimensions</b> Dimensioni di ingombro totali	13' x 7' 1/2 x h 6'
0 - 10 mt / min	<b>Rapid Speed</b> Rapido	0 - 33' / min
2.500 Kg	<b>Weight</b> Peso Tavolo	5.500 lb
± 0,1 mm	<b>Positioning Accuracy</b> Precisione di posizionamento	± 0,004"
± 0,075 mm	<b>Repeatability</b> Ripetibilità	± 0,003"
± 0,1 mm	<b>Ball Bar Ø 300 mm (12")</b> Precisione di circolarità Ø 300 mm	± 0,004"

### STANDARD AVAILABLE MODELS MODELLI DISPONIBILI

LT 44	1.250 x 1.250 mm 4' x 4'
LT 510	3.400 x 1.650 mm 11' x 5' 1/2
LT 612	4.000 x 1.650 mm 13' x 5' 1/2



# ACCURATE FLYING BRIDGE SYSTEM

SISTEMA FLYING BRIDGE

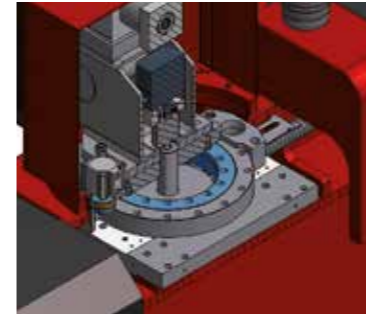

FBR 510 - Revolving system  
FBR 510 - Sistema rotante

Double Table with automatic revolving Flying Bridge system which allows an easy and safe material loading and offloading without any interruption of the cutting process.

Doppio tavolo di lavoro con sistema rotante automatico del ponte per garantire in sicurezza un facile carico e scarico del materiale senza interruzione del processo di taglio.

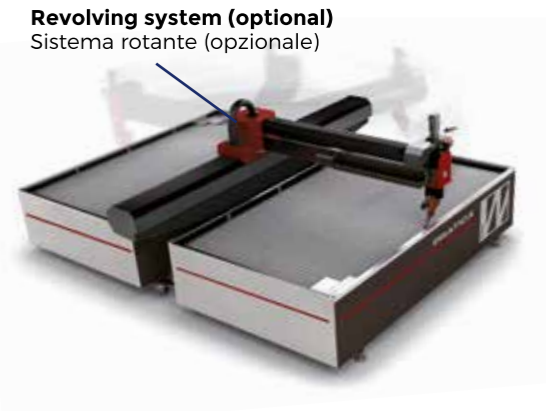

Revolving system (optional)  
Sistema rotante (opzionale)



## FB 510

Separate Steel Tank with Ball screws motion system and automatic lubrication.  
Vasca in acciaio separata e viti a ricircolo di sfere con lubrificazione automatica centralizzata.

3 axis Numerical Control System.  
Sistema a Controllo Numerico a 3 assi.



X = 3.000 mm Y = 2.000 mm Z = 200 mm	<b>Net Cutting Area</b> Area netta di taglio	X = 10' Y = 6' 1/2' Z = 8"
3.650 mm x 2.240 mm	<b>Inner Table Working Area</b> Dimensioni interne vasca	12' x 7' 1/2"
4.200 mm x 3.000 mm x h 1.800 mm	<b>Overall Dimensions</b> Dimensioni di ingombro totali	14' x 10' x h 6' 1/2"
0 - 12 mt / min	<b>Rapid Speed</b> Rapido	0 - 40' / min
3.000 Kg	<b>Weight</b> Peso Tavolo	7.500 lb
± 0,075 mm	<b>Positioning Accuracy</b> Precisione di posizionamento	± 0,003"
± 0,05 mm	<b>Repeatability</b> Ripetibilità	± 0,002"
± 0,075 mm	<b>Ball Bar Ø 300 mm (12")</b> Precisione di circolarità Ø 300 mm	± 0,003"

### STANDARD AVAILABLE MODELS MODELLI DISPONIBILI

FB 510	3.000 x 2.000 mm 10' x 6' 1/2"
FB 612	4.000 x 2.000 mm 13' x 6' 1/2"
FB 812	4.000 x 2.500 mm 13' x 8"
FB 620	6.100 x 2.000 mm 20' x 6' 1/2"
FB 820	6.100 x 2.500 mm 20' x 8"



## GANTRY SYSTEM SISTEMA A PONTE



EDGE 5 axis 2D bevel  $\pm 55^\circ$  with I.T.C. technology and touch probe sensor for accurate position calibration.

Sistema a 5 assi per il controllo della conicità e del taglio inclinato 2D a  $\pm 55^\circ$ . Sistema di tastatore per il posizionamento e mantenimento preciso della distanza sul piano.

EDGE 5 axis (optional)



2<sup>nd</sup> Head System (optional)  
Doppia Testa (opzionale)

### CL 510

**Stainless Steel Tank.**  
3-5 axis NC gantry technology with helical rack and pinion motion system and automatic lubrication.

Vasca in ACCIAIO INOX.  
Controllo numerico a 3-5 assi.  
Sistema gantry di trasmissione con pignone e cremagliera elicoidale con sistema di lubrificazione automatico.



X = 3.400 mm Y = 1.800 mm Z = 200 mm	<b>Net Cutting Area</b> Area netta di taglio	X = 11' Y = 6' Z = 8"
3.675 mm x 2.100 mm	<b>Inner Table Working Area</b> Dimensioni interne vasca	12' x 7'
4.500 mm x 2.300 mm x h 1.800 mm	<b>Overall Dimensions</b> Dimensioni di ingombro totali	15' x 7' 1/2 x h 6' 1/2
0 - 30 mt / min	<b>Rapid Speed</b> Rapido	0 - 100' / min
3000 Kg	<b>Weight</b> Peso Tavolo	6.700 lb
$\pm 0,075$ mm	<b>Positioning Accuracy</b> Precisione di posizionamento	$\pm 0,003$ "
$\pm 0,05$ mm	<b>Repeatability</b> Ripetibilità	$\pm 0,002$ "
$\pm 0,075$ mm	<b>Ball Bar <math>\varnothing</math> 300 mm (12")</b> Precisione di circolarità $\varnothing$ 300 mm	$\pm 0,003$ "

#### STANDARD AVAILABLE MODELS MODELLI DISPONIBILI

CL 44	1.250 x 1.250 mm 4' x 4'
CL 510	3.400 x 1.800 mm 11' x 6'
CL 610	3.400 x 2.000 mm 11' x 6' 1/2
CL 612	4.000 x 2.000 mm 13' x 6' 1/2
CL 620	6.100 x 2.000 mm 20' x 6' 1/2

**Waterjet**  
**PLASMAJET**

**WATERJET COMBINED TECHNOLOGY**  
TECNOLOGIA COMBINATA

**Double NC Human Interface**  
Doppia Interfaccia Grafico del Controllo



HMI WATERJET

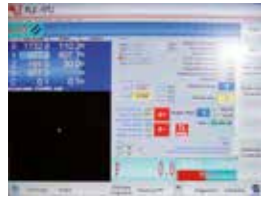

HMI PLASMA



**Output current** - Corrente in uscita 130A  
**Power supply** - Potenza assorbita 18,8 kW  
Gas: Plasma gas O<sub>2</sub>, N<sub>2</sub>, F5\*, H35\*\*, Air, Ar  
**Gas pressure** - Pressione del Gas: 8,3 bar

<b>HPR 130XD (Optional - Opzionale 260 XD)</b>	
<b>Mild steel cut capacity</b> - Prestazioni sul Ferro	
<b>Dross free</b> - Senza scoria	16 mm (5/8")
<b>Production (pierce)</b> - Produzione	32 mm (1 1/4")
<b>Rough cut</b> - Separazione	38 mm (1 1/2")
<b>Stainless steel cut capacity</b> - Prestazioni su Acciaio Inox	
<b>Production (pierce)</b> - Produzione	20 mm (3/4")
<b>Rough cut</b> - Separazione	25 mm (1")
<b>Aluminum cut capacity</b> - Prestazioni su Alluminio	
<b>Production (pierce)</b> - Produzione	20 mm (3/4")
<b>Rough cut</b> - Separazione	25 mm (1")

**PL510**

**Single Axis with integrated Waterjet and Plasma heads.**

Asse singolo con teste Waterjet e Plasma integrate.



X = 3.050 mm Y = 1.600 mm Z = 200 mm	<b>Net Cutting Area</b> Area netta di taglio	X = 10' Y = 5' 1/2" Z = 8"
3.675 mm x 2.100 mm	<b>Inner Table Working Area</b> Dimensioni interne vasca	12' x 7'
4.500 mm x 2.300 mm x h 1.800 mm	<b>Overall Dimensions</b> Dimensioni di ingombro totali	15' x 7' 1/2" x h 6' 1/2"
0 - 30 mt / min	<b>Rapid Speed</b> Rapido	0 - 100' / min
3000 Kg	<b>Weight</b> Peso Tavolo	6.700 lb
± 0,075 mm	<b>Positioning Accuracy</b> Precisione di posizionamento	± 0,003"
± 0,05 mm	<b>Repeatability</b> Ripetibilità	± 0,002"
± 0,075 mm	<b>Ball Bar Ø 300 mm (12")</b> Precisione di circolarità Ø 300 mm	± 0,003"

**STANDARD AVAILABLE MODELS**  
MODELLI DISPONIBILI

PL 44	1.000 x 1.000 mm 3' x 3'
PL 510	3.050 x 1.600 mm 10' x 5'
PL 610	3.050 x 2.000 mm 10' x 6' 1/2"
PL 612	4.000 x 2.000 mm 13' x 6' 1/2"
PL 620	6.100 x 2.000 mm 20' x 6' 1/2"



## 5 AXIS 2D SYSTEM SISTEMA A 5 ASSI 2D



The 5 axis Evolution 3D cutting system automatically maintains a constant distance between the nozzle and the material, through the use of a touch probe device. This is also done while the cutting head is rotating. The interpolation of the axis can reach up to  $\pm 69^\circ$  (optional  $90^\circ$ ), in any 3D direction.

Il Sistema speciale Evolution 3D a 5 assi interpolanti è in grado mediante tastatore di mantenere automaticamente la distanza costante dall'ugello durante la lavorazione piana e di posizionarsi correttamente sul materiale per eseguire un'interpolazione inclinata a  $\pm 69^\circ$  (optional  $90^\circ$ ) in ogni direzione 3D.



LX5  $\pm 69^\circ$  (Optional)

Edge 5™  $\pm 55^\circ$  (Optional)

## DX 510 5 AXIS / DX 510 5 ASSI (X2)

5 axis 2D "Edge 5™" option with I.T.C™ Technology, Touch Probe, Laser Pointer and Vacuum Assist. Separate Stainless Steel Tank and Ball Screw motion system with automatic lubrication.

5 assi 2D "Edge 5™" e I.T.C™ integrato, con tastatore, puntatore laser e vacuostato. Vasca in ACCIAIO INOX separata e Viti a ricircolo di sfere con sistema di lubrificazione automatico.



X = 3.350 mm Y = 1.600 mm Z = 200 mm A = $\pm 55^\circ$ C = $\pm 55^\circ$	<b>Net Cutting Area</b> Area netta di taglio	X = 11' Y = 5' Z = 8" A = $\pm 55^\circ$ C = $\pm 55^\circ$
3.600 mm x 1.850 mm	<b>Inner Table Working Area</b> Dimensioni interne vasca	12' x 6'
4.800 mm x 2.300 mm x h 1.800 mm	<b>Overall Table Dimensions</b> Dimensioni esterne tavolo	16' x 7' 1/2" h x 6'
0 - 20 mt / min	<b>Rapid Speed</b> Rapido	0 - 67' / min
5.000 Kg	<b>Weight</b> Peso Tavolo	11.000 lb
$\pm 0,05$ mm	<b>Positioning Accuracy</b> Precisione di posizionamento	$\pm 0,002$ "
$\pm 0,025$ mm	<b>Repeatability</b> Ripetibilità	$\pm 0,001$ "
$\pm 0,05$ mm	<b>Ball Bar <math>\varnothing</math> 300 mm (12")</b> Precisione di circolarità $\varnothing$ 300 mm	$\pm 0,002$ "

### STANDARD AVAILABLE MODELS MODELLI DISPONIBILI

DX 44	1.250 x 1.250 mm 4' x 4'	DX 1012	4.000 x 3.350 mm 13' x 11'
DX 510	3.350 x 1.600 mm 11' x 5' 1/2	DX 620	6.100 x 2.000 mm 20' x 6' 1/2
DX 610	3.350 x 2.000 mm 11' x 6' 1/2	DX 820	6.100 x 2.500 mm 20' x 8'
DX 612	4.000 x 2.000 mm 13' x 6' 1/2	DX 1020	6.100 x 3.350 mm 20' x 11'
DX 812	4.000 x 2.500 mm 13' x 8'	DX 1040	12.200 x 3.350 mm 40' x 11'
		DX 1340	12.200 x 4.000 mm 40' x 13'

## SPECIAL CUSTOMIZED MACHINES

MACCHINE SPECIALI PERSONALIZZATE

**SPECIAL CUSTOMIZED MACHINES:**  
 Single or Double Gantry Bridge,  
 with multiple heads and multiple  
 combined technologies

**MACCHINE SPECIALI  
 PERSONALIZZATE:**  
 A ponte gantry singolo o doppio,  
 con teste multiple e con tecnologie  
 multiple combinate

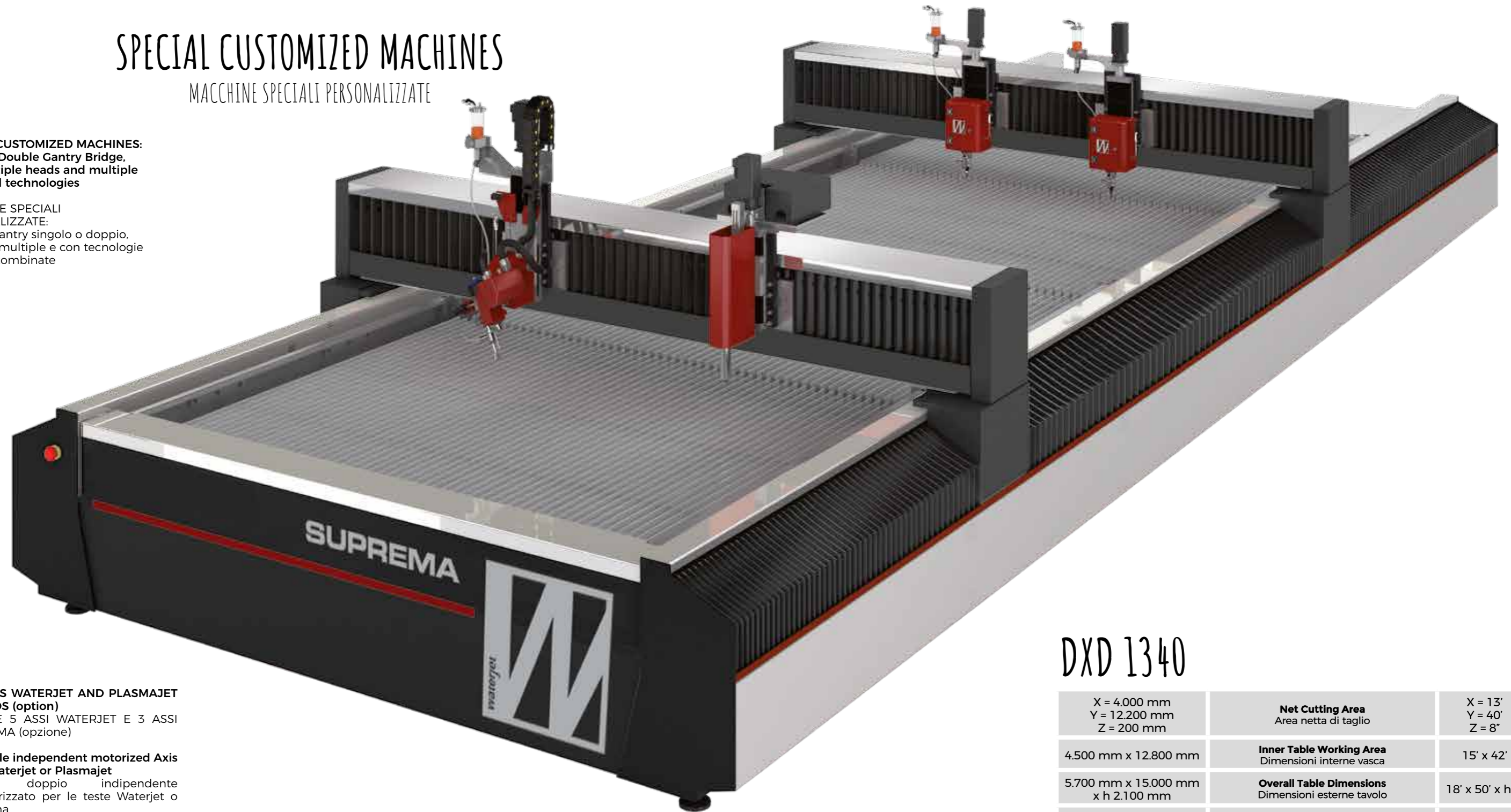

**5 AXIS WATERJET AND PLASMAJET  
 HEADS (option)**  
 TESTE 5 ASSI WATERJET E 3 ASSI  
 PLASMA (opzione)

**Double independent motorized Axis  
 for Waterjet or Plasmajet**  
 Asse doppio indipendente  
 motorizzato per le teste Waterjet o  
 Plasma



### DXD 1340

X = 4.000 mm Y = 12.200 mm Z = 200 mm	<b>Net Cutting Area</b> Area netta di taglio	X = 13' Y = 40' Z = 8"
4.500 mm x 12.800 mm	<b>Inner Table Working Area</b> Dimensioni interne vasca	15' x 42'
5.700 mm x 15.000 mm x h 2.100 mm	<b>Overall Table Dimensions</b> Dimensioni esterne tavolo	18' x 50' x h 7'
0 - 30 mt / min	<b>Rapid Speed</b> Rapido	0 - 100' / min
12.000 Kg	<b>Weight</b> Peso Tavolo	26.000 lb
± 0,08 mm	<b>Positioning Accuracy</b> Precisione di posizionamento	± 0,003"
± 0,05 mm	<b>Repeatability</b> Ripetibilità	± 0,002"
± 0,08 mm	<b>Ball Bar Ø 300 mm (12")</b> Precisione di circolarità Ø 300 mm	± 0,003"



# HIGH PRESSURE TECHNOLOGY

TECNOLOGIA AD ALTA PRESSIONE



## KMT WATERJET NEOLINE SLIV 40 HP 3.800 BAR - 55,000 PSI

Model Modello	Pressure Pressione	Power Potenza	Water Consumption Consumo d'acqua	Orifice Size Diametro Orifizio	Number of Cutting Heads Numero Teste di taglio
NE 40	3.800 Bar -55,000 PSI	40 HP - 30 KW	3,1 lt/min - 0,8 gal/min	0,3 mm - 0,012"	1 - 2



## KMT WATERJET STREAMLINE SLVI 30/50 HP 4.130 BAR - 60,000 PSI

Model Modello	Pressure Pressione	Power Potenza	Water Consumption Consumo d'acqua	Orifice Size Diametro Orifizio	Number of Cutting Heads Numero Teste di taglio
SLVI 30	4.130 Bar -60,000 PSI	30 HP - 22 KW	2,2 lt/min - 0,55 gal/min	0,28 mm - 0,011"	1
SLVI 50	4.130 Bar -60,000 PSI	50 HP - 37 KW	3,8 lt/min - 0,9 gal/min	0,35 mm - 0,014"	1 - 2



## KMT WATERJET STREAMLINE PRO<sub>3</sub> 60/125 HP 6.200 BAR - 90,000 PSI

Model Modello	Pressure Pressione	Power Potenza	Water Consumption Consumo d'acqua	Orifice Size Diametro Orifizio	Number of Cutting Heads Numero Teste di taglio
PRO <sub>3</sub> 60	6.200 Bar -90,000 PSI	45 KW - 60HP	2,5 lt/min - 0,61 gal/min	0,25 mm - 0,010"	1 - 2
PRO <sub>3</sub> 125	6.200 Bar -90,000 PSI	93 KW - 125 HP	5,5 lt/min - 1,37 gal/min	0,35 mm - 0,014"	1 - 2 - 4



## KMT WATERJET TRILINE TL-I 30 HP 3.800 BAR - 55,000 PSI

Model Modello	Pressure Pressione	Power Potenza	Water Consumption Consumo d'acqua	Orifice Size Diametro Orifizio	Number of Cutting Heads Numero Teste di taglio
TL-I 30	3.800 Bar -55,000 PSI	30 HP - 22 KW	3,1 lt/min - 0,8 gal/min	0,3 mm - 0,012"	1 - 2

# ACCESSORIES AND OPTIONAL

ACCESSORI E OPZIONI

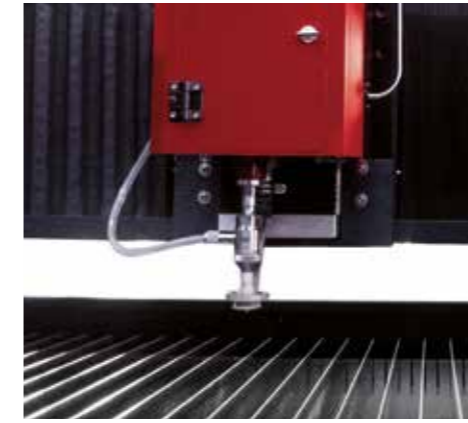

**Touch probe Sensor with Anticollision, Laser Pointer, and Vacuum Assist**  
Tastatore con Anticollisione, Laser e Vacuostato

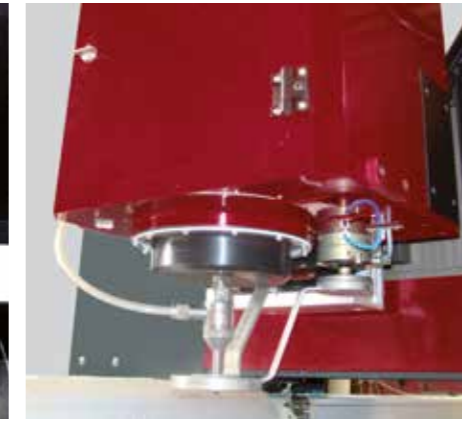

**I.T.C.™ - Intelligent Tapering Control system with self positioning touch probe and anticollision device**  
Sistema a 4 assi per la compensazione della conicità I.T.C.™ (Intelligent Tapering Control) con tastatore e sistema anticollisione

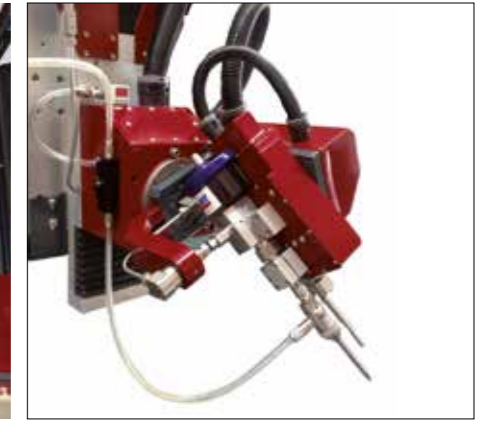

**Edge 5 axis ±55° interpolating system with I.T.C.™ (Intelligent Tapering Control)**  
Sistema 2D Edge a 5 assi interpolanti ±55° con I.T.C.™ (Intelligent Tapering Control)



**5 axis 3D Evolution ±69° interpolating system with ±300° or infinite (optional) rotation**  
Sistema Evolution 3D a 5 assi interpolanti ±69° con rotazione ±300° o infinita (opzionale)



**Multiple heads system**  
Sistema a teste multiple



**Pre-drilling cnc mechanical system**  
Sistema di preforo meccanico o per bisellatura fori



**Tube cutting lathe system**  
Sistema di taglio tubi



**Semi-Automatic Sludge removal system**  
Sistema di evacuazione fanghi semi automatico



**Automatic Sludge Removal Equipment with or without Submerge Cutting System**  
Sistema di Evacuazione Automatico con o senza Taglio Sommerso

# NUMERICAL CONTROL S510

CONTROLLO NUMERICO S510



- 1) The Graphic-Window shows the shape of the work piece and the cutting path. It can be used to define the start point for the restart function.
- 2) The Display-Bar shows Position, Time, Offset, Feedrates and Override data.
- 3) Operational Functions for the different Modes (Jog, Manual, Automatic).
- 4) Main menu switches for the different Modes
- 5) Main Switch Board.
- 6) USB Port.
- 7) Override.
- 8) Teleassistance.

- 1) L'ambiente grafico mostra la sagoma e il profilo di taglio in modo interattivo: può essere utilizzato anche per un facile riposizionamento da qualsiasi punto.
- 2) Visualizzazione dei dati di Posizione, Tempo, Offset, Velocità di taglio e Percentuale di riduzione.
- 3) Funzioni Operative rapide per i differenti tipi di lavorazione (Jog, Manuale, Automatico).
- 4) Tasti del Menu principale per la selezione delle funzioni.
- 5) Pulsantiera per le funzioni principali
- 6) Porta USB.
- 7) Variatore di velocità.
- 8) Teleassistenza.

WaterCad-Cam is a CAD/CAM solution designed to easily automate the programming of Waterjet machines.

Within the same program environment, you can design or import a part by DXF and DWG, consult the plate warehouse, perform manual or automatic nesting, execute manual or automatic cutting sequences, generate the NC program and calculate time and costs.

- Automatic lead-ins/lead-outs
- Water jet technology tables
- Speed reduction in corners
- Support of technological elements such as chamfers (bevels), loops and bridges
- True-shape NESTING, including parts in parts (optional)

In the technological tables MATERIAL, THICKNESS and FINISHING for the required task can be selected; an ISO program (NC Code) is automatically generated, ready for uploading to the CNC by ETHERNET or USB. The software also allows for an Estimations related to the programmed job prior to the actual cutting being run, showing COSTS, TIMING and CUTTING LENGTHS.

WaterCad-Cam è un software sviluppato su un ambiente solo. Nel programma è possibile progettare o importare da DXF e DWG una parte, consultare il magazzino, eseguire il nesting automatico o in modalità manuale, eseguire sequenze di taglio in automatico o in modalità manuale, generare il programma NC e calcolare i tempi e i costi.

- Attacco e stacco automatico
- Tabelle tecnologiche relative alla tecnologia waterjet
- Riduzione della velocità negli angoli forature speciali
- Sostegno di elementi tecnologici, come smussi, loop e ponti
- Nesting base matriciale (opzionale)

Nelle tabelle tecnologiche e' possibile selezionare MATERIALE, SPESSORE e FINITURA per il lavoro da eseguire; viene così generato in automatico il programma ISO (Codice) pronto da essere trasferito al controllo numerico mediante rete ETHERNET o porta USB.

Il software permette anche di generare un preventivo automatico del lavoro, prima di eseguirne la produzione effettiva, mostrandone COSTO, TEMPO e LUNGHEZZA DI TAGLIO.

# QUALITY CONTROL

CONTROLLO QUALITÀ



**Renishaw Laser Straightness inspection and verification**

Controlli di precisione di rettilineità mediante Laser Renishaw

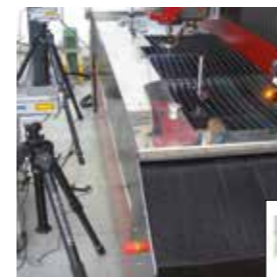

**Double Renishaw Laser inspection and verification of Positioning Accuracy and Compensation (linearity)**

Controlli simultanei di precisione di posizionamento lineare mediante doppi Laser Renishaw

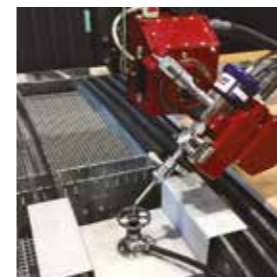

**EDGE 5 Calibration Automatic 5 Axis Calibrating System by a special NC test routing and device**

Calibrazione EDGE 5 Sistema di calibrazione automatica del 5 assi con strumentazione speciale

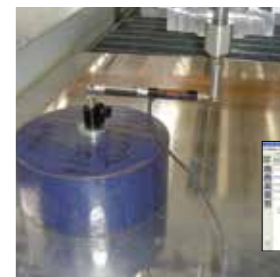

**Ball Bar inspection and verification**

Controllo circolarità con Ball bar



**Benchmark cut for final verification**

Test finale del campione di taglio

# APPLICATIONS

## APPLICAZIONI

### Metals/Metallo



### Composites/Compositi



YOUR BEST  
WATERJET  
PERFORMANCE



Waterjet Corporation was set up in 1991 and operates as a manufacturer of NC machine tools for high-pressure waterjet cutting and finishing of stone, composites, glass, steel, alloys and other materials. Waterjet solutions stand out for their innovative approach, cutting accuracy, reliability and strong customisation at the customer's request. Production and R&D are carried out in-house by highly qualified personnel, which now consist of more than 60 people.

Sales are handled by a widespread sales network of exclusive distributors and foreign branches in the US and the Middle East. An international network that guarantees quality, fast and efficient after-sales support.

Waterjet guarantees the best waterjet cutting performance.

Waterjet Corporation nasce nel 1991 e si afferma come produttore di macchine utensili a controllo numerico dedicate al taglio e alla finitura a getto d'acqua a elevata pressione di materiali lapidei, compositi multistrato, vetro, acciaio, leghe e altri. Le soluzioni Waterjet si distinguono per innovazione, precisione del taglio, affidabilità ed elevato potenziale di personalizzazione. Le attività di Produzione e di Ricerca & Sviluppo sono svolte internamente da personale addetto altamente specializzato di oltre 60 persone.

La vendita si esplica attraverso una capillare rete di vendita costituita da distributori in esclusiva e da succursali estere negli USA e in Medio Oriente. Una rete internazionale capace di garantire un supporto post vendita di qualità, pronto ed efficace.

Waterjet garantisce la migliore performance di taglio ad acqua.



Italy, Monza



Italy, Monza



Italy, Agrate Brianza



USA, Elgin



#### HEADQUARTERS

##### Waterjet Corporation S.r.l.

Viale G.B. Stucchi, 66/23 - 20900 Monza (MB) - Italy  
T. (+39) 039 204971 - F. (+39) 039 2842479  
www.waterjetcorp.com - waterjet@waterjet.it

##### Waterjet USA LLC

65 N River Lane, Suite 209 - Geneva, IL 60134 - USA  
T. (+1) (630) 208-1567 - F. (+1) (630) 208-1993  
www.waterjetusa.com - info@waterjetusa.com

##### Waterjet Middle East Fzco

P.o. Box: 18650 Lob 16 No 16619  
Jebel Ali Free Zone, United Arab Emirates  
T. (+971) 4 8816337 - F. (+971) 4 8871311  
www.waterjetmiddleeast.com - waterjme@eim.ae